

A white graphic element resembling a feather or a stylized arrow pointing downwards, positioned behind the Featherlite logo text.

FEATHERLITE

PALO DURO

premium burnished cmu

featherlitetexas.com



Colors burnished & rockface

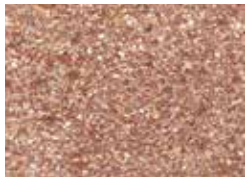

Colonial Red



Colonial Red



Midnight Sky



Midnight Sky



Sunset



Sunset



Graphite



Graphite



Cordova Stone

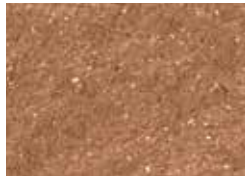

Cordova Stone



Gray



Gray



Mocha



Mocha



Shadow Gray



Shadow Gray



Sandstone



Sandstone



Terrazo



Terrazo



Sahara Sand



Sahara Sand

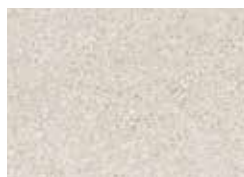

Ashland



Ashland



Classic Buff



Classic Buff



Limestone



Limestone



Texas Shell



Texas Shell

*cover and left, Gymnasium in Tahoka, Texas
Graphite, Sandstone, Limestone*

Standard Shapes

Available from Featherlite's Lubbock Plant, our line of premium burnished concrete masonry units.

Standard Details:

Standard chamfer dimension is 1.4" wide. Chamfers larger than 1.4" wide will require an additional charge and are considered "slopes."

Bullnose radius equals 1".

All vertical edges on a cored unit can be chamfered or bullnosed. All vertical and horizontal edges on a solid unit can be chamfered or bullnosed.

Chamfered/bullnosed edges minimize chipping and eliminate sharp corners.

Scores are 3/8" wide x 3/8" deep.

Scores shall be tuck-pointed and tooled using a concave jointer to match the head and bed joints.

Minimum return dimension for quirk miter is 1/2".

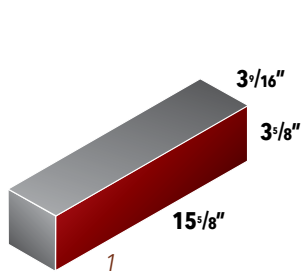

1
4" Half High Solid

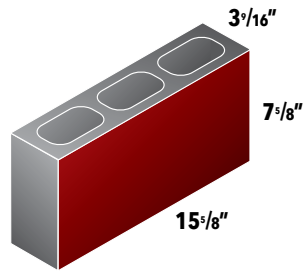

4" Stretcher

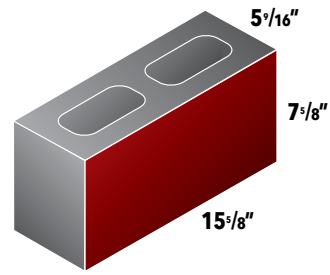

6" Stretcher

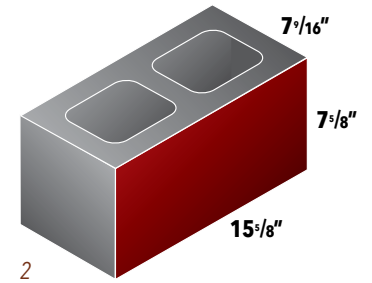

2
8" Stretcher

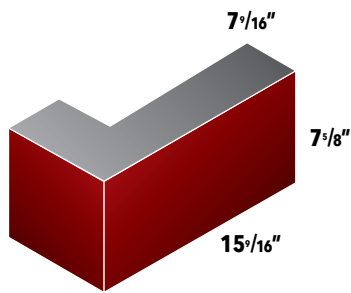

L Corner

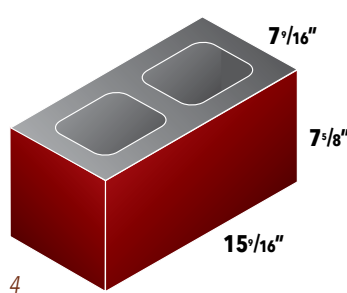

4
8" Corner

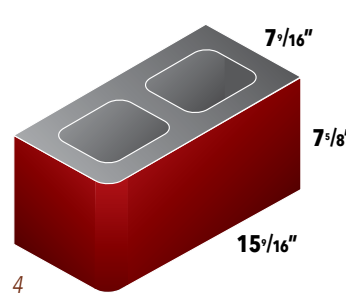

4
8" Bullnose Corner

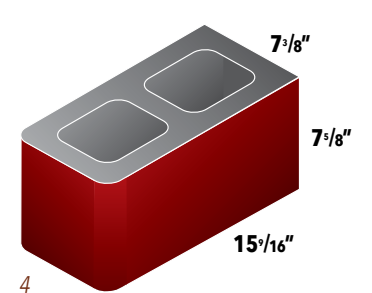

4
8" Double Bullnose

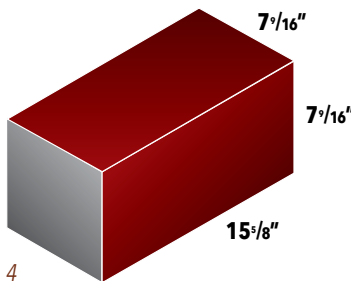

4
Square Cap

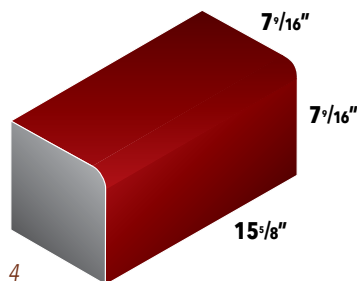

4
Bullnose Cap

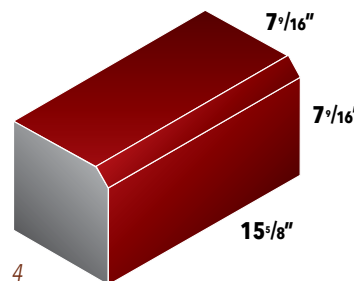

4
Chamfer Cap

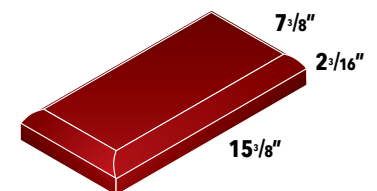

Chamfer Cap All Sides

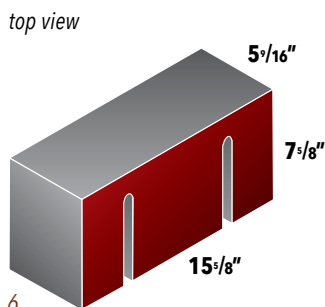

6
6" Soundblox RSC Acoustical Unit

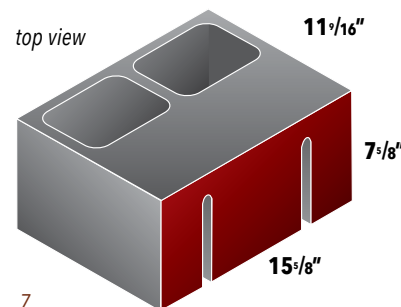
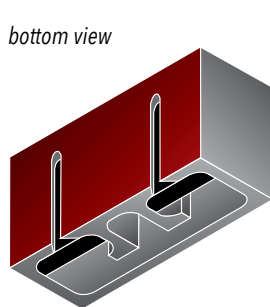

7
12" Soundblox RSC/RF Acoustical Unit

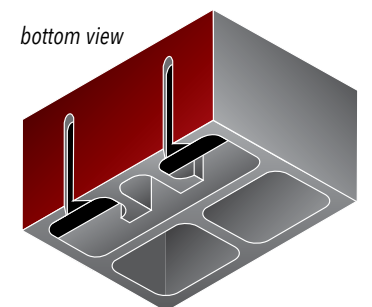

Notes:

- 1 also available: 2 1/4", 6", 8", 10", 12" thicknesses
- 2 also available: 2 1/4", 10", 12" thicknesses
- 3 also available: 6", 10", 12" thicknesses
- 4 also available: 2 1/4", 4", 6", 10", 12" thicknesses
- 5 with/without drip

- 6 also available: 4", 8", 12" thicknesses—cannot be vertically reinforced
- 7 also available in 8" thickness—can be vertically reinforced
- 8 solid units
- 9 solid units, also available: 4", 6" thicknesses

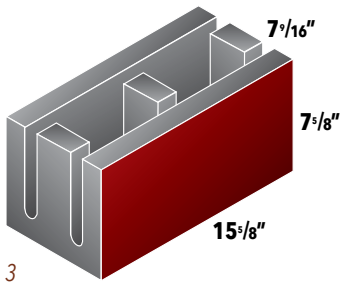

3
Knockout

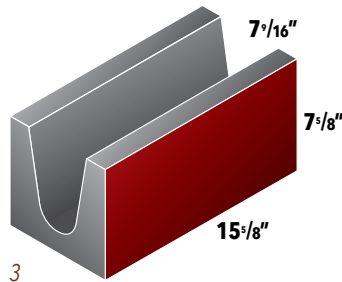

3
Lintel

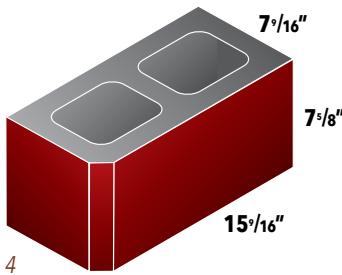

4
8" Chamfer Corner

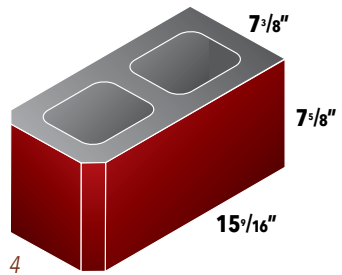

4
8" Double Chamfer

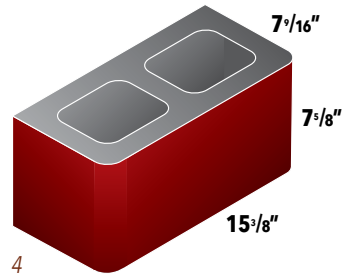

4
8" Bullnose Column

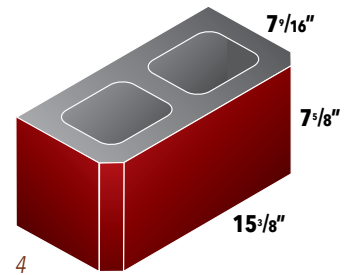

4
8" Chamfer Column

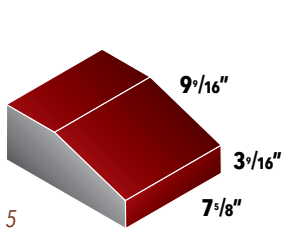

5
8" Sill

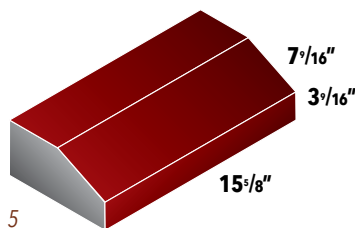

5
16" Sill

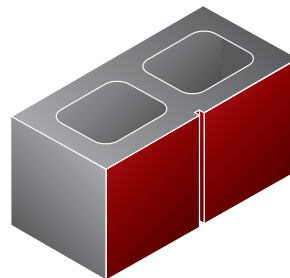

Score

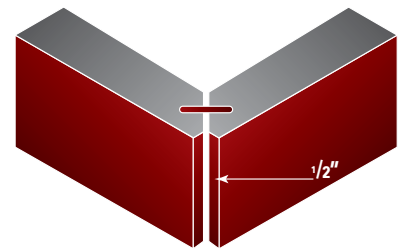

Quirk Miter

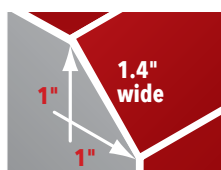

Chamfer Detail



Bullnose Detail

Oversized Units

Notes:

- 5 with/without drip
- 8 solid units
- 9 solid units, also available: 4", 6" thicknesses

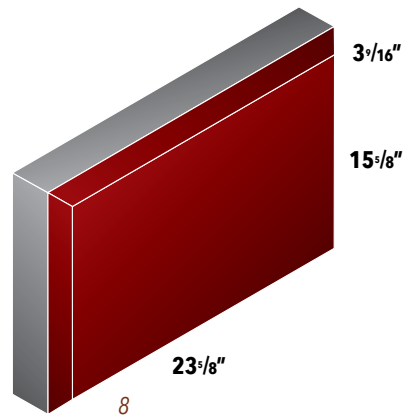
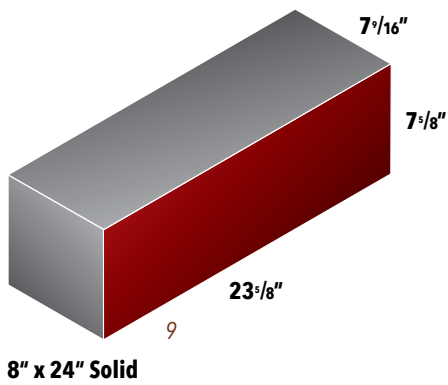
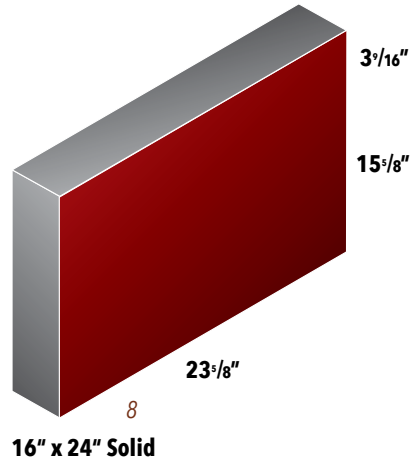
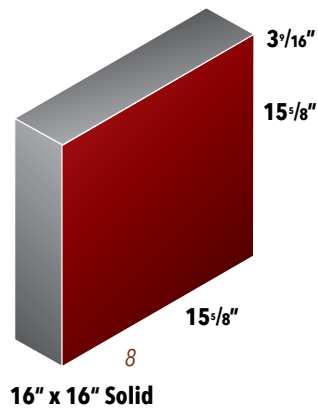
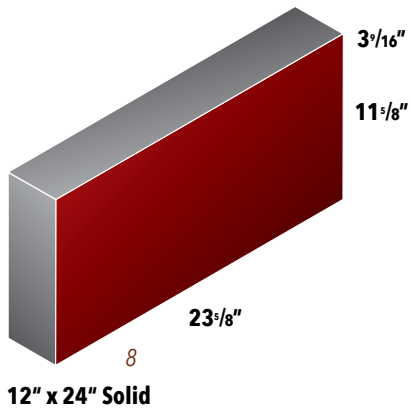
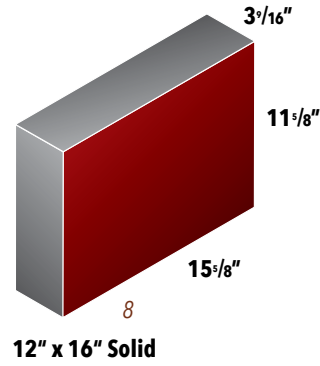
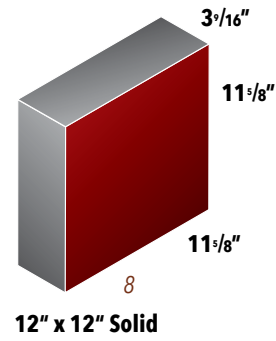
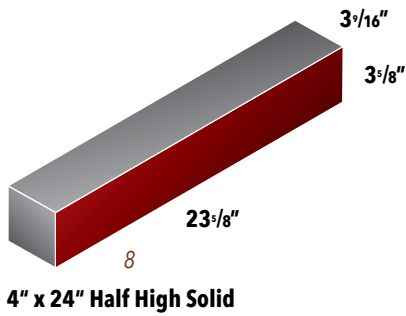
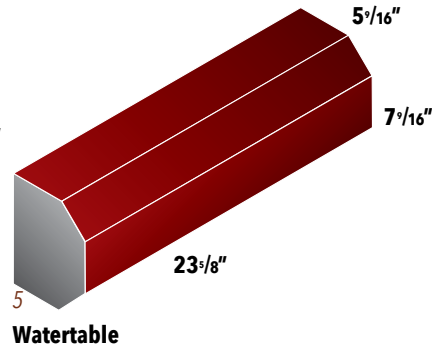
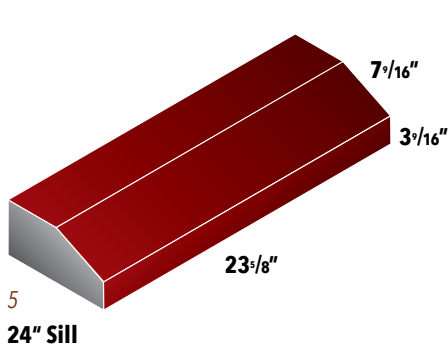



shadow gray burnished above, rockface below

shadow gray burnished above, rockface below

Highschool in Brownfield, Texas, Limestone





Graphite, Sandstone, Limestone



featherlitetexas.com

r20240513